

Adaptec™ 39320A/U320 SCSI RAID 0 or 1 User's Guide

[Introduction](#)

[Hardware Installation](#)

[BIOS RAID Configuration And Management](#)

[Windows Operating System Driver Installation](#)

[SCSI Cables and Connectors](#)

[Adaptec U320 SCSI RAID 0 or 1 Specifications](#)

[Adaptec U320 SCSI RAID 0 or 1 Troubleshooting](#)

[Adaptec U320 SCSI RAID Regulatory Information](#)

[Adaptec U320 SCSI RAID Glossary](#)



NOTE: A NOTE indicates important information that helps you make better use of your computer.



NOTICE: A NOTICE indicates either potential damage to hardware or loss of data and tells you how to avoid the problem.



CAUTION: A CAUTION indicates a potential for property damage, personal injury, or death.

Information in this document is subject to change without notice.

© 2004 Dell Inc. All rights reserved.

Reproduction in any manner whatsoever without the written permission of Dell Inc. is strictly forbidden.

Trademarks used in this text: *Dell*, the *DELL* logo, and *Dell OpenManage* are trademarks of Dell Inc.; *Intel*, *Pentium*, and *Celeron* are registered trademarks of Intel Corporation; *Microsoft* and *Windows* are registered trademarks of Microsoft Corporation. Red Hat is a registered trademark of Red Hat, Inc.

Other trademarks and trade names may be used in this document to refer to either the entities claiming the marks and names or their products. Dell Inc. disclaims any proprietary interest in trademarks and trade names other than its own.

Model Adaptec U320 SCSI RAID 0 or 1

March 2005 P/N NC234 Rev. A00

Initial release: April 2004

Last revised: March 2005

Introduction

Adaptec™ U320 SCSI RAID 0 or 1 User's Guide

- [Overview](#)
- [RAID Storage Management Utilities](#)
- [System Requirements](#)
- [Adaptec U320 SCSI RAID 0 or 1 Features](#)
- [Configuration Features](#)
- [RAID Performance Features](#)
- [RAID Management Features](#)
- [Fault Tolerance Features](#)
- [Software Utilities](#)
- [Operating System Drivers and Utility](#)
- [Adaptec U320 SCSI RAID 0 or 1 Firmware](#)

Overview

The Adaptec U320 SCSI RAID 0 or 1 is a high-performance 64-bit/133-MHz PCI-X, dual-channel SCSI card with integrated RAID 0 and 1. It provides data protection at the fastest SCSI speeds available up to 640 MB/sec total throughput using Ultra320 SCSI Low Voltage Differential (LVD) devices.

The Adaptec U320 SCSI RAID 0 or 1 controller has the following features:

- Two independent bootable SCSI channels
- 15 multifunction devices per channel
- Mixing of LVD and SE devices, with associated performance degradation. (HVD devices are not supported.)
- Wide or Narrow SCSI data path
- CRC-32 error detection for Ultra320/Ultra160 modes during data I/O phases in LVD mode only
- Automatic termination control
- Manual termination override for multi-initiator environments
- Fuse-protected (up to 1.25 A) termination power circuit
- SCSI card and devices are configurable using SCSISelect®, the BIOS Configuration utility

RAID Storage Management Utilities

The Adaptec U320 SCSI RAID 0 or 1 includes the following software tools to manage your storage subsystem:

- RAID Storage Manager—Browser based storage management software that provides all of the creation, management, data logging, messaging, and control needed to manage arrays on the operating system. For details, refer to the RAID Storage Manager documentation.
- BIOS Configuration utility—Configuration utility that is part of the controller's built-in BIOS-based code. The utility can be started by pressing <Ctrl><A> during BIOS startup. For details, refer to "[BIOS RAID Configuration And Management](#)".

System Requirements

The following system requirements are discussed:

- Storage Requirements
- SCSI Drive Requirements
- Hardware Requirements

Storage Requirements

RAID Storage Manager and the Adaptec U320 SCSI RAID 0 or 1 device drivers require 20 MB of disk space.

 **NOTE:** This information is provided as a guide for allocating resources on your system. Space requirements may vary in subsequent releases. Allocate more room on your hard drive if in doubt.

SCSI Drive Requirements

While the Adaptec U320 SCSI RAID 0 or 1 is designed to work with Ultra320 and Ultra160 SCSI hard disk drives, it will operate, at a reduced level of performance, with all legacy Ultra2, Ultra, and Single-Ended (SE) SCSI devices. Use of High Voltage Differential (HVD) devices is not supported.

More details about configuring and using SCSI drives are available in "[Configuring SCSI Drives](#)".

Hardware Requirements

Specification	Requirement
Voltage Requirements	5-V/33 MHz and 3.3V/66-MHz
System Bus Interface Requirements	PCI/X 133 MHz
Mouse	Yes
Monitor	SVGA color monitor using a resolution of at least 800 x 600 with 16-bit color

Adaptec U320 SCSI RAID 0 or 1 Features

Feature	Support
RAID Levels	RAID 0, 1
On-board Memory	512-KB (to 4-megabit) FLASH, EFI capable 4-KB SEEPROM with 3-wire interface
System Bus Interface	PCI-X/PCI
BIOS Utility	SCSISelect
OS Utility	RAID Storage Manager
Hot Spares	Global Hot Spare Support
Supported Operating Systems	Microsoft Windows 2000/XP (32 bit and 64 bit), Red Hat Linux 4.0 (32 bit and 64 bit)
Flashable ROM	Yes
Event logging and notification	Yes
Interface hard disks	LVD, Ultra320, Ultra160, Ultra2, Wide SE

 NOTE: For information on RAID configuration and planning, see "RAID Configuration and Management". For more information on hardware installation, see "Installation".

The Adaptec U320 SCSI RAID 0 or 1 enables you to connect up to 30 SCSI devices—such as Ultra320/Ultra160 hard disk drives, scanners, and CD-ROM drives—to any Intel-based or Intel-compatible system with 64- or 32-bit PCI/PCI-X expansion slots. Ultra320 is an enhanced SCSI technology that transfers data at up to 640 MB/sec. Ultra320 SCSI allows cable length of up to 12 meters for optimal connectivity and flexibility.

The Adaptec U320 SCSI RAID 0 or 1 has two independent SCSI channels, each with a maximum throughput of 320 MB/sec.

For optimum performance and throughput, the Adaptec U320 SCSI RAID 0 or 1 card must be installed in a 64-bit, 133-MHz, PCI-X slot with Ultra320 devices. However, the HBA is fully functional in legacy PCI systems because it supports conventional 33- and 66-MHz PCI transactions in both 32- and 64-bit modes. The HBA also supports legacy SCSI operations, such as SPI-3 Double Transition (DT) clocking.

The Adaptec U320 SCSI RAID 0 or 1 card is backwards compatible with virtually any legacy Ultra2, Ultra, and Single-Ended (SE) SCSI device, except High Voltage Differential (HVD) devices. However, performance is degraded to SE speed, and SE cable length restrictions must be adhered to, when an SE device is connected to the bus. Dual-independent channels allow LVD and SE devices to operate separately at peak performance.

Configuration Features

Specification	Feature
---------------	---------

RAID Levels	RAID 0, 1
Interface Channels	Two independent SCSI channels
Devices supported per channel	15
Host Interface	PCI-X 133 MHz
Storage Interface	Ultra320 SCSI
Multiple logical drives/per controller	2
Event logging Controllers supported in system	System Event Log and Controller Event Log
Online Capacity Expansion	Yes
Hot spare support	Global Hot Spare Support
Flashable firmware	Yes
Hot swap devices supported	Yes
Supported Devices	See your system documentation for supported devices
Mixed capacity hard disk support	Yes
Internal Connectors	Two 68-pin Internal LVD/SE connectors
External Connectors	Two 68-pin External VHDCI connectors

Disk Configuration Features

Specification	Feature
Supported hard disk Capacity	Maximum 2 TB
Online RAID Migration	Single volume to RAID 1 in SCSI <i>Select</i> BIOS utility
User Specified Rebuild Rate	Yes

RAID Performance Features

Specification	Feature
Storage Interface transfer rate	320 MB/s per channel
Maximum Outstanding I/Os per drive	16
Supported Stripe Sizes	16KB, 32KB, 64KB
Maximum number of concurrent commands	32

RAID Management Features

Specification	Feature
Drive roaming	Yes

Support for concurrent multiple stripe sizes	Yes
Management utility support in OS	Yes
DMI Support	Yes

Fault Tolerance Features

Specification	Feature
SMART Support	Yes
Drive failure detection	Automatic
Drive rebuild using hot spares	Yes
Parity Generation and checking	Yes

Software Utilities

Specification	Feature
Graphical user interface	Yes
Management utility	Yes

Operating System Drivers and Utility

The Adaptec U320 SCSI RAID 0 or 1 includes drivers to support the following operating systems:

- Microsoft® Windows®2000, XP (32 bit and 64 bit)
- Red Hat Linux 4.0 (32 bit and 64 bit)

Adaptec U320 SCSI RAID 0 or 1 Firmware

Specification	Feature
Disconnect/Reconnect	Optimizes Ultra320 SCSI Bus seek
Tagged Command Queuing	Tagged Command Features
Scatter/Gather	Yes
Supported Stripe Sizes	16, 32, 64 KB
Rebuild	Supported

[Back to Contents Page](#)

Hardware Installation

Adaptec™ U320 SCSI RAID 0 or 1 User's Guide

- [Safety Precautions](#)
- [Installing the Adaptec U320 SCSI RAID 0 or 1 Controller](#)
- [Configuring SCSI Drives](#)
- [Installing Hard Drives](#)

Safety Precautions

For more information on safety instructions for your system, see the *System Information Guide* or *Product Information Guide* that came with your system.

Do not handle the card until you discharge any static electricity by touching a grounded metal object (such as the exposed metal parts on the back of your system.)

 **NOTE:** Handle the card by its edges or metal bracket. Do not touch the gold connector or any components on the card.

Installing the Adaptec U320 SCSI RAID 0 or 1 Controller

 **CAUTION:** Be sure to disconnect the system's power before you remove the cover and install the Adaptec U320 SCSI RAID 0 or 1 controller.

 **CAUTION:** Be sure to use an approved ESD workstation and wrist-strap when handling the host adapter to prevent damage from discharge of static electricity.

The Adaptec U320 SCSI RAID 0 or 1 controller card fits into any available:

- 64-bit PCI/PCI-X expansion slot
- 32-bit PCI expansion slot

 **NOTE:** Installing the Adaptec U320 RAID 0 or 1 controller in a 32-bit slot will decrease the maximum performance of the controller.

To install the Adaptec U320 SCSI RAID 0 or 1 controller:

1. Open the system chassis.
2. Remove the inside slot cover of an appropriate slot on the system board. See the documentation that came with your system for more information.
3. Install the Adaptec U320 SCSI RAID 0 or 1 controller into the open slot as follows:

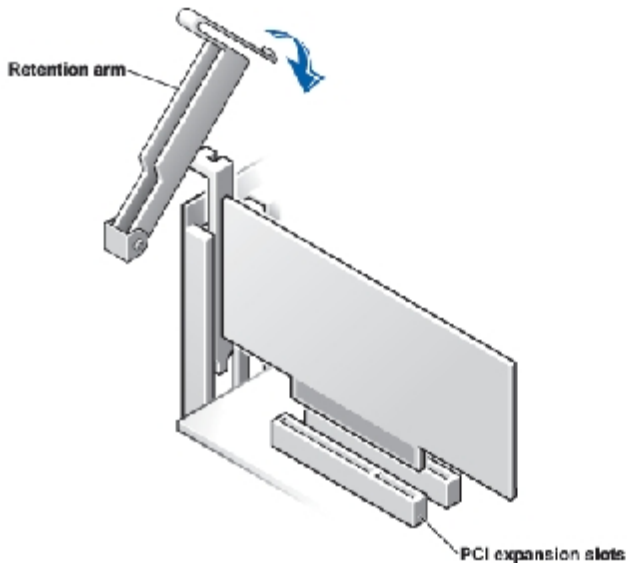

4. Secure the controller with the system's retaining bracket.
5. Attach the activity light cable to the activity light connector on the Adaptec U320 SCSI RAID 0 or 1 controller and the motherboard if needed. Make sure that pin 1 on the connector is aligned with pin 1 of the cable.

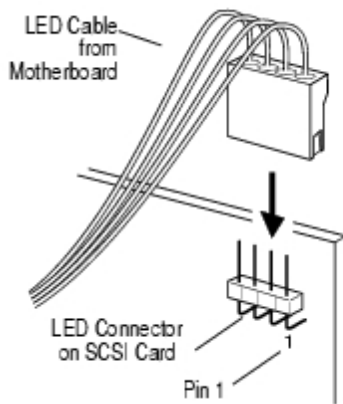

Configuring SCSI Drives

There are several things you may need to do to your SCSI hard drives and devices before you connect them to the Adaptec U320 SCSI RAID 0 or 1:

- Check the SCSI IDs
- Set the termination
- Connect the power cables

Since setup can vary from device to device, always refer to the device's documentation for specific instructions.

NOTE: If you connect Wide Ultra/Ultra SCSI devices to the same SCSI channel as Ultra320/160 and Ultra2 SCSI devices, the data transfer rate for the Ultra320/160 and Ultra2 SCSI devices will drop to Ultra SCSI performance levels. To achieve maximum data transfer rates for the newer SCSI devices, be sure to connect them on their own SCSI channel.

The following are some guidelines for setting SCSI IDs and termination on your devices.

SCSI IDs

The Adaptec U320 SCSI RAID 0 or 1 and each device you connect to it must have a unique SCSI ID number ranging from 0 to 15 on each channel. No two devices on the same SCSI channel can have the same SCSI ID.

The Adaptec U320 SCSI RAID 0 or 1 is preset to ID 7 for each channel and should not be changed. If you boot from a SCSI hard disk, make sure the hard disk SCSI ID is set to 0. (Most SCSI hard disks are preset to SCSI ID 0 at the factory.) The SCSI IDs for internal devices are usually set with jumpers; SCSI IDs for external devices are usually set with a switch on the back of the device.

SCSI Termination

Proper termination of channels used with SCSI devices is critical in having the system work properly. The basics of termination are:

- Use SCSI cables certified for Ultra320 operation to allow the system to work at full speed.

NOTE: The cable provided with the Adaptec U320 SCSI RAID 0 or 1 has a built-in multi-mode terminator on one end. This is meant to be located at the opposite end of the cable from the attachment to the controller. None of the drives attached to this cable should be terminated.

- Enable termination of the devices on each physical end of a SCSI cable (see note above). Use multi-mode terminated cables only with termination on that channel disabled.
- When using multiple SCSI channels on a single controller, as is possible on the Adaptec U320 SCSI RAID 0 or 1, terminate each channel separately.

SCSI termination for Adaptec U320 SCSI RAID 0 or 1 is configured through the BIOS configuration utility. The controller has two possible termination settings, as shown:

Setting	Function
Auto (Default)	Used for most cabling conditions
Disabled	Disabled controller termination unconditionally

The following figures show various SCSI cabling examples:

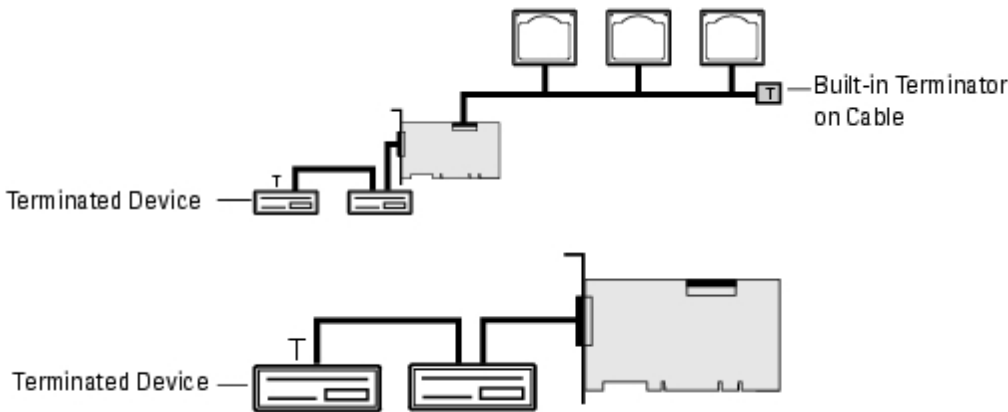

SCSI Cables

Dell recommends using Ultra320 SCSI drives and LVD SCSI cables designed and rated for Ultra320 use. These can be purchased from Dell at www.dell.com. Using cables not rated for U320 operation may adversely impact the performance of the system.

Installing Hard Drives

The Adaptec U320 SCSI RAID 0 or 1 Controller supports up to 4 drives. For optimal performance, install identical drives of the same model and capacity. The drives' matched performance allows the array to function at the highest performance level.

While the Adaptec U320 SCSI RAID 0 or 1 is designed to work with Ultra320 and Ultra160 SCSI hard disk drives, it will operate, at a reduced level of performance, with all legacy Ultra2, Ultra, and Single-Ended (SE) SCSI devices. Use of High

Voltage Differential (HVD) devices is not suggested. HVD devices will adversely affect other devices attached to the same channel and could cause a working Ultra320 channel to become nonfunctional, due to distance constraints inherent in using some of these older devices.

The Adaptec U320 SCSI RAID 0 or 1 controller supports the following RAID levels:

- RAID Level 0 : Up to 4 hard drives
- RAID Level 1 : 2 hard drives

Plan to utilize the number of hard drives supported by the controller and the desired RAID level.

More details about configuring and using SCSI drives and devices are available in "[Configuring SCSI Drives](#)".

Connecting Internal Hard Drives

To connect your internal SCSI drives:

1. Install the hard drives into the hard drive bays of your system. Refer to your system documentation for more information.
2. Attach the nonterminated end of the 68-pin internal LVD SCSI cable to the Adaptec U320 SCSI RAID 0 or 1 adapter's Channel A Connector.

 **NOTE:** You may connect your SCSI hard drives to the internal LVD/SE or external VHDCI connector on the Adaptec U320 SCSI RAID 0 or 1 adapter.

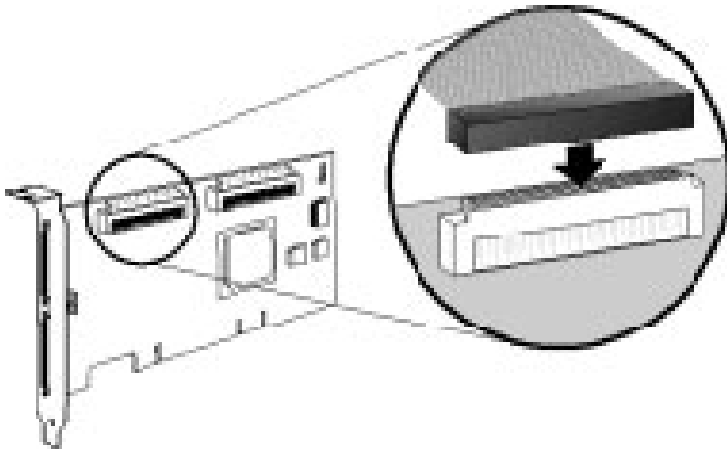

3. Plug the internal Ultra320/160 and Ultra2 SCSI devices to the other cable connectors, starting with the connector at the terminated end of the cable.
4. Repeat for each additional hard drive as applicable.
5. Attach power cables to drives as applicable.

Connecting External Devices

 **NOTE:** Refer to your system documentation to determine which devices are supported with your system.

To connect your external SCSI devices:

1. Connect one end of an external SCSI cable to the external Ultra 320/160 connector on the Adaptec U320 SCSI RAID

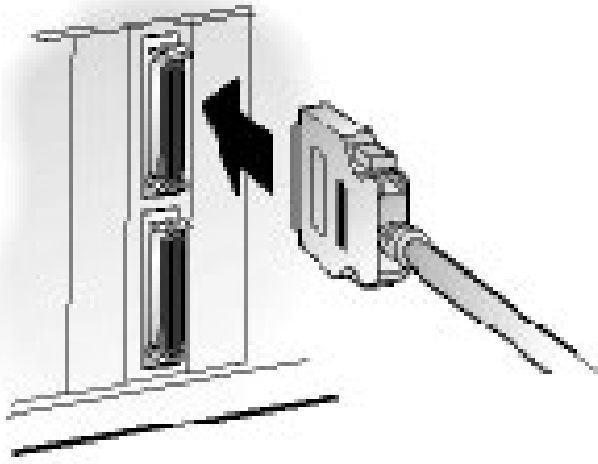

0 or 1.

2. Connect the other end of the cable to a SCSI connector on the back of an external device. If you are installing only one external device, terminate the device and skip to "[step 4](#)".

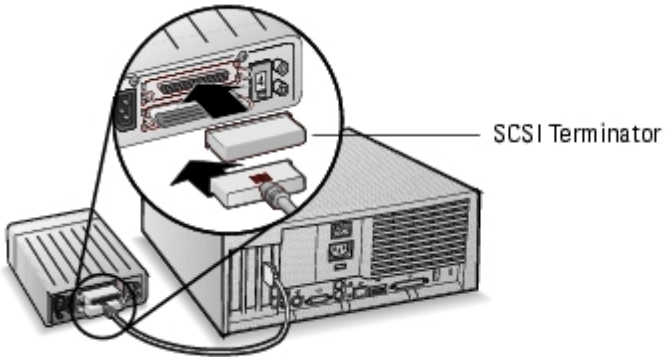

3. Connect the other external SCSI devices by linking each device to the previous one, as shown below. Terminate only the device at the end of the chain.

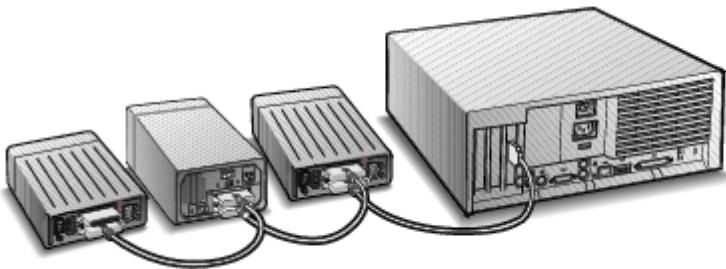

4. Connect power cables to all external device(s) and to the system.

[Back to Contents Page](#)

BIOS RAID Configuration And Management

Adaptec™ U320 SCSI RAID 0 or 1 User's Guide

- [Configuration Strategies](#)
- [RAID Availability](#)
- [Configuration Planning](#)
- [Entering the BIOS Configuration Utility](#)
- [Controller Configuration](#)
- [Using SCSISelect Settings](#)
- [Using HostRAID Settings](#)
- [Array Setup](#)
- [Managing Arrays](#)
- [Deleting Arrays](#)
- [Using SCSI Disk Utilities](#)

Configuration Strategies

Three factors drive the implementation of RAID configurations:

- Fault Tolerance, (Drive Availability)
- Performance
- Capacity

The needs and priorities in regards to each of these factors determine the optimal RAID level and configuration for the specific usage for which the RAID array is intended.

Maximizing Fault Tolerance

RAID Level	Fault Tolerance Description
0	Not fault tolerant. Drive failures are not tolerated.
1	Disk mirroring; a complete copy of data on a secondary hard drive. One drive failure can be tolerated.

Optimizing Performance

RAID	Performance Characteristics
0	Highest Read and Write Performance, no fault tolerance.
1	Good Read Performance and Lower Write Performance.

Maximizing Capacity

RAID Level	Description	Drives Supported	Capacity
0	Striping	0 - 4 maximum drives supported	(Number of disks) x (smallest disk's capacity)
1	Mirroring	2	Smallest disk's capacity

RAID Availability

RAID availability depends not only on the RAID level and number of attached hard drives, but also on whether spare drives are available.

Spare Drives and Data Recovery

Spare drives can be utilized by physically replacing drives following a hard drive failure. Hot Spares are drives that are attached to the controller, but are not actively available for data storage. Upon a hard drive failure the hot spare replaces the failed drive and fault tolerance is restored by rebuilding data onto the spare drive.

 NOTE: A spare can only be used by the system to rebuild an array if it is the same size as, or larger than, the failed drive.

The following types of spares are supported by the Adaptec U320 SCSI RAID 0 or 1 controller:

- Global Hot Spares —Protects every array that the spare drive has sufficient available capacity to protect.

Global Hot Spares

When an array member (a drive) fails, a global hot spare of sufficient capacity is automatically used to restore the data contained on the failed drive. The behavior of the system after a failure depends on the size of the spare relative to the drive it is replacing:

- If the global hot spare is the same size, or less than 100 MB larger than the drive it is replacing, it becomes a member of the array with the failed drive and ceases to be marked as a global hot spare.
- If the global hot spare is larger than the drive it is replacing by 100 MB or more, the spare replaces the failed drive, yet remains a global hot spare. The unused portion of the global hot spare is available for use in the event of future failure.

- ➡ **NOTICE:** It is recommended that you *not* use the unused portion of the global hot spare as it may result in a single drive RAID 1.

Drive Roaming

Drive roaming enables a RAID volume to be moved from one controller to another controller without interruption. Each drive has a unique ID which can be physically changed by setting a jumper to allow drive roaming.

Formatting

Most drives can re-assign sectors to recover from failures.

Formatting a drive may allow re-assigning of failed sectors, allowing a RAID controller to utilize the drive. See "[Verifying or Formatting a Disk](#)" for more information.

Rebuilding

The Rebuild feature of the Adaptec U320 SCSI RAID 0 or 1 allows for an array to synchronize the hard drives, and restore fault tolerance in a redundant RAID array. See "[Rebuilding Arrays](#)" for more information.

Configuration Planning

Optimal configurations are different for each unique purpose. When planning your RAID configuration, factors to consider are:

- Number of hard drives
- Purpose of the Array
 - Fault Tolerance
 - Performance
 - Capacity
- Spare Drives
 - Global Hot Spares

Entering the BIOS Configuration Utility

During POST of the system a splash screen will appear:

```
Adaptec HostRAID BIOS vX.XX
Copyright 2004 Adaptec, Inc. All Rights Reserved.
```

```
◀ ◀ ◀ Press <Ctrl><A> for SCSISelect (TM) Utility! ▶ ▶ ▶
```

Enter the BIOS utility by pressing <Ctrl><A>.

From the device menu that appears, select a channel and press <Enter>.

The BIOS Configuration Utility menu displays the following options:

Configure/View SCSI Controller Settings
Configure/View HostRAID Settings
SCSI Disk Utilities

 **NOTE:** To select an option from this menu or from any of the menus, move the cursor to the option with the Up/Down arrow keys and press <Enter>. In some cases, selecting an option displays another menu. Press <Esc> at any time to return to the previous menu.

Configure/View SCSI Controller Settings—enables you to change SCSI device and controller settings without opening the system chassis or handling the card.

Configure/View HostRAID Settings—enables you to create, manage, and delete arrays from the controller's BIOS.

SCSI Disk Utilities—includes low-level format and disk media verification SCSI hard disks.

Controller Configuration

The Controller Configuration section allows a user to change SCSI and controller specific options. The following table lists the available and default settings for each *SCSISelect* option. For dual channel cards, the settings marked as Auto-sync are automatically synchronized for both SCSI channels—for example, if you change the Boot Channel option to B First on Channel A, the change will apply to Channel B as well. All other options can be set separately for each of the two SCSI channels.

The default settings are appropriate for most systems and should not be changed. Run *SCSISelect* if you need to change or view current settings, or if you need to use the SCSI disk utilities. See "[Using SCSISelect Settings](#)" for descriptions of each option.

SCSISelect Options	Available Settings	Default Setting
SCSI Bus Interface Definitions:		
SCSI Controller ID	0-15	7

SCSI Controller Parity	Enabled Disabled	Enabled
SCSI Controller Termination: Ch. A	Automatic, Disabled	Automatic
Ch. B	Automatic, Disabled	Automatic
Boot Device Configuration Options—BBS Systems Only:		
Select Master SCSI Controller [Auto-sync]	A, B	A
Boot SCSI Controller [Auto-sync]	A, B	A
Boot Device Configuration—Non-BBS Systems Only:		
Select Master SCSI Controller [Auto-sync]	A, B	A
Boot SCSI Controller [Auto-sync]	A, B	A
Boot SCSI ID [Auto-sync]	0-15	0
Boot LUN Number* [Auto-sync]	0-7	0
SCSI Device Configuration Options:		
Sync Transfer Rate (MB/sec)	320, 160, 80.0, 66.6, 40.0, 33.3, 20.0, 10.0, ASYN	320
Packetized	Yes, No	Yes (Enabled)
QAS	Yes, No	No (Disabled)
Initiate Wide Negotiation	Yes, No	Yes (Enabled)
Enable Disconnection	Yes, No	Yes (Enabled)
Send Start Unit Command	Yes, No	Yes (Enabled)
BIOS Multiple LUN Support*	Yes, No	No (Disabled)
Include in BIOS Scan**	Yes, No	Yes (Enabled)
Advanced Configuration:		
Reset SCSI Bus at IC Initialization	Enabled, Disabled	Enabled
Display <Ctrl> <A> Messages during BIOS Initialization [Auto-sync]	Enabled, Disabled	Enabled
Extended INT 13 Translation for DOS Drives > 1 GB	Enabled, Disabled	Enabled

Post Display Mode [Auto-sync]	Verbose, Silent, Diagnostic	Verbose
SCSI Controller INT 13 Support	Enabled Disabled: Scan Bus Disabled: Not Scan	Enabled
Domain Validation	Enabled, Disabled	Enabled
Support Removable Disks Under INT 13 as Fixed Disks**	Disabled, Boot Only, All Disks	Disabled
BIOS Support for Bootable CD-ROM**	Enabled, Disabled	Enabled
* Setting is valid only if Multiple LUN Support is enabled. **Settings are valid only if host adapter BIOS is enabled.		

Using *SCSISelect* Settings

Starting and Exiting *SCSISelect*

To start *SCSISelect*:

1. When you turn on or reboot your system, press <Ctrl><A> to access the Configuration Utility when prompted by the following message:
2. Select the controller to be configured and press <Enter>.
3. From the **Configuration Utility** menu, select **S**

The Controller Configuration and SCSI Configuration menu options are displayed.

To exit *SCSISelect*, press <Esc> until a message prompts you to exit. If you changed any controller settings, you are prompted to save the changes before you exit. Select **Yes** to exit and reboot the system. Any changes you made in *SCSISelect* take effect after the system boots.

Using the *SCSISelect* Menus

To select an option, use the arrow keys to move the cursor to the option, then press <Enter>. In some cases, selecting an option displays another menu. You can return to the previous menu at any time by pressing <Esc>.

To restore the original *SCSISelect* default values, press <F6> from the main *SCSISelect* screen.

To toggle the display between color and monochrome modes, press <F5> from the main *SCSISelect* screen.

 **NOTE:** Some monitors do not support the ability to toggle between color and monochrome modes.

SCSI Bus Interface Options

- **SCSI Controller ID**—(Default: 7) Sets the SCSI ID for the SCSI card. The Adaptec U320 SCSI RAID 0 or 1 is set at 7, which gives it the highest priority on the SCSI bus. We recommend that you do not change this setting.
- **SCSI Controller Parity**—(Default: Enabled) SCSI cards perform parity checking to verify the accuracy of data transfer on the SCSI bus. Most currently available SCSI devices support parity checking. However, if a device on the SCSI bus does not support parity checking, disable this option. This setting changes parity for the entire SCSI controller and the way it looks at each ID on that controller. You cannot mix devices that do and do not support parity checking on the same SCSI bus.
- **SCSI Controller Termination**—(Default: Automatic) Determines the termination setting for the SCSI card. The default setting is Automatic, which allows the SCSI card to adjust the termination as needed. We recommend that you do not change this setting.

Boot Device Configuration Options – BBS Systems Only

The BBS (BIOS Boot Specification) enables the BIOS to identify all IPL devices in the system, prioritize them in the order you select, and sequentially go through each device to allow booting.

- **Select Master SCSI Controller**—Enables you to select the master SCSI controller. The master SCSI card does not necessarily have to be the same as the boot SCSI controller.
- **Boot SCSI Controller**—Enables you to select which SCSI controller is the boot SCSI controller. The boot SCSI controller does not necessarily have to be the same as the master SCSI controller.

Boot Device Configuration – Non-BBS Systems Only

In a non-BBS system, it is the SCSI card BIOS, not the system BIOS, that controls the Select Master SCSI Controller, Boot SCSI ID, and Boot LUN Number settings.

- **Select Master SCSI Controller**—(Default: A First) Enables you to select the master SCSI controller. The master SCSI card does not necessarily have to be the same as the boot SCSI controller. If you change this setting, the change automatically applies to both SCSI channels.
- **Boot SCSI Controller**—Enables you to select which SCSI controller is the boot SCSI controller. The boot SCSI controller does not necessarily have to be the same as the master SCSI controller. If you change this setting, the change automatically applies to both SCSI channels.
- **Boot SCSI ID**—(Default: 0) Specifies the SCSI ID of your boot device. We recommend that you do not change the default setting. If you change this setting, the change automatically applies to both SCSI channels.
- **Boot LUN Number**—(Default: 0) Specifies which LUN (Logical Unit Number) to boot from on your boot device. This setting is not valid unless Multiple LUN Support is enabled (see "[Advanced Configuration Options](#)"). If you change this setting, the change automatically applies to both SCSI channels.

SCSI Device Configuration Options

SCSI Device Configuration options can be set individually for each connected SCSI device.

 **NOTE:** To configure settings for a SCSI device, you must know its SCSI ID. See "[Using SCSI Disk Utilities](#)".

- **Sync Transfer Rate (MB/sec)**—(Default: see following table) The BIOS may negotiate for a transfer rate between controller and device of up to 80 MB/sec for Wide transfers and 40 MB/sec for Narrow transfers. The

BIOS can use this setting to set the starting point for negotiating the synchronous data transfer rate to a slower speed. For example, in the case of Wide transfers, if the Sync Transfer Rate is set to:

- **320, 160, or 80**—The BIOS negotiates at 80 MB/sec.
- **40 or lower**—The BIOS negotiates at the Sync Transfer Rate setting.

Eventually, the BIOS completes negotiation. Later, the device driver takes over. The device driver uses this setting as a starting point for negotiating data transfers.

The following table describes the maximum synchronous transfer rates. The default settings are designated by an asterisk (*).

Negotiation Rate	Allowable Maximum Rates (MB/sec)
Narrow mode	*40.0, 33.3, 20.0, 16.6, 10.0, 5.0, ASYN
Wide mode	*320, 160, 80.0, 66.6, 40.0, 33.3, 20.0, 10.0, ASYN

 NOTE: If Initiate Wide Negotiation is set to No, the rates for Wide devices are half those shown in the table.

- **Packetized**—(Default: Yes) Packetized protocol is required to operate at 320 MB/sec. When enabled, this option is available if it is implemented in the device drivers. However, this option is not supported by the BIOS.
- **QAS**—(Default: No) Quick Arbitration and Selection reduces the overhead of control release on the SCSI bus from one device to another. This improvement reduces command overhead and maximizes bus utilization. When enabled, this option is available if it is implemented in the device drivers. However, this option is not supported by the BIOS.
- **Initiate Wide Negotiation**—(Default: Yes) Enables the SCSI controller to initiate Wide Negotiation with the SCSI target. When set to Yes, the SCSI card attempts 16-bit data transfer (wide negotiation). When set to No, the SCSI card uses 8-bit data transfer unless the SCSI device requests wide negotiation.

 NOTE: Set Initiate Wide Negotiation to No if you are using an 8-bit SCSI device that hangs or exhibits other performance problems with 16-bit data transfer rate enabled.

- **Enable Disconnection**—(Default: Yes) When set to Yes, Enable Disconnection allows the SCSI device to disconnect from the SCSI bus. When set to No, the SCSI device cannot disconnect from the SCSI bus. Leave the setting at Yes if two or more SCSI devices are connected to the SCSI card. When Enable Disconnection is set to No, the SCSI device cannot disconnect from the SCSI bus, packetized transfers cannot occur, and transfer rates are set at Ultra160 levels.
- **Send Start Unit Command**—(Default: Yes) When set to Yes, sends the Start Unit Command to the SCSI device at bootup. This reduces the load on a system's power supply by allowing the SCSI card to turn on SCSI devices one-by-one when the system boots; otherwise, all SCSI devices turn on at the same time.

 NOTE: Check the device documentation to make sure the device supports the command. On most devices, you must also change a switch or jumper setting on the device to enable the device to respond to the command.

The following options have no effect if the SCSI card BIOS is disabled. (The SCSI card BIOS is normally enabled by default.)

- **BIOS Multiple LUN Support**—(Default: No) Leave this setting at No if the device does not have multiple LUNs. When set to Yes, the SCSI card BIOS provides boot support for a SCSI device with multiple LUNs (for example, a CD jukebox device in which multiple CDs can be accessed simultaneously).
- **Include in BIOS Scan**—(Default: Yes) When set to Yes, the SCSI card BIOS controls the SCSI device if it is an INT 13 device (such as a SCSI disk drive) without device driver software. When set to No, the SCSI card

BIOS does not control the SCSI device and device driver software is required. The BIOS can support up to eight INT 13 devices without an additional device driver.

Advanced Configuration Options

- ➔ NOTICE: Do not change the Advanced Configuration Options unless absolutely necessary and you thoroughly understand the consequences of the change.
- **Reset SCSI Bus at IC Initialization**—(Default: Enabled) When set to Enabled, the BIOS resets the SCSI bus at POST time and then waits two seconds before scanning the bus for SCSI devices. If this option is disabled, the SCSI card BIOS does not issue a SCSI reset and there is no two-second delay.
- **Display <Ctrl> <A> Messages during BIOS Initialization**—(Default: Enabled) When set to Enabled, the SCSI card BIOS displays the Press <Ctrl> <A> for SCSISelect (TM) Utility! message on your screen during system bootup. If this setting is disabled, you can still invoke the SCSISelect utility by pressing <Ctrl><A> after the SCSI card BIOS banner appears. If you change this setting, the change automatically applies to both SCSI channels.
- **Extended INT 13 Translation for DOS Drives > 1 GByte**—(Default: Enabled) When set to Enabled, provides an extended translation scheme for SCSI hard disks with capacities greater than 1 GB. This setting is necessary only for current versions of MS-DOS; it is not required for other operating systems, such as NetWare or UNIX.
- ➔ NOTICE: Changing the translation scheme destroys all data on the drive. Be sure to back up your disk drives before changing the translation scheme.
- **Post Display Mode**—(Default: Verbose) During Power-On Self Test (POST), the amount of information displayed depends on the mode. If you change this setting, the change automatically applies to both SCSI channels. The following modes are available:
 - **Verbose**—The results of the SCSI bus scan are displayed, but the results of the PCI bus scan are not displayed.
 - **Silent**—Nothing is displayed about POST, not even the Dell banner. However, error messages are displayed if there is a problem on the SCSI bus or SCSI devices.
- ➔ NOTICE: Setting this feature to Silent completely disables the messages displayed by the Dell SCSI Card during the restart of the system. You will have to remember where in the POST cycle of the BIOS the Press <Ctrl> <A> for SCSISelect (TM) Utility! message was displayed, and press <Ctrl><A> at that time to get into SCSISelect. If you press <Ctrl><A> too early or too late, you will not be able to enter into the cards setup.
 - **Diagnostic**—The PCI and SCSI bus scan results are displayed separately. There is a pause between PCI and SCSI scans.
- **SCSI Controller INT 13 Support**—(Default: Enabled) This option controls the state of the BIOS at POST time. The following settings are available:
 - Enabled—Supports INT 13 for booting from a SCSI hard disk drive connected to the SCSI card. If you use this option, the following options are available:
 - Extended INT 13 Translation for DOS Drives > 1 GB
 - Support Removable Disks Under INT 13 as Fixed Disks
 - BIOS Support for Bootable CD-ROM
 - Disabled:NOT Scan—Select this option if all the devices on the SCSI bus (for example, CD-ROM drives) are controlled by software drivers and do not need the BIOS, and you do not want the BIOS to scan the SCSI bus. SCSISelect remains available if needed.
 - Disabled:Scan Bus—Select this option if all the devices on the SCSI bus (for example, CD-ROM drives) are controlled by software drivers and you need the BIOS to scan the SCSI bus. Allows devices to spin up

according to the setting of the Send Start Unit Command. SCSISelect remains available if needed.

The following options have no effect if the SCSI card BIOS is disabled. (The SCSI card BIOS is normally enabled by default.)

- **Domain Validation**—(Default: Enabled) Determines the optimal transfer rate for each device on the SCSI bus and sets transfer rates accordingly. When enabled, this option is available if it is implemented in the device drivers. However, this option is not supported by the BIOS.
- **Support Removable Disks Under INT 13 as Fixed Disks**—(Default: Disabled) Determines which removable-media drives are supported by the SCSI card BIOS. The options are as follows:
 - **Disabled**—No removable-media drives running under DOS are treated as hard disk drives. Software drivers are required because the drives are not controlled by the BIOS.

➡ **NOTICE:** You may lose data if you remove a removable-media cartridge from a SCSI drive controlled by the SCSI card BIOS while the drive is on. If you want to be able to remove the media while the drive is on, install the removable-media software driver and set Support Removable Disks Under BIOS as Fixed Disks to **Disabled**.

- **Boot Only**—Only the removable-media drive designated as the boot device is treated as a hard disk drive.
- **All Disks**—All removable-media drives supported by the BIOS are treated as hard disk drives.

✍ **NOTE:** The Boot Only and All Disks options are available only if the SCSI Controller BIOS option is set to Enabled.

- **BIOS Support for Bootable CD-ROM**—(Default: Enabled) When set to Enabled, the SCSI card BIOS allows the system to boot from a CD-ROM drive. If booting from a hard disk or other device, make sure no bootable CD is inserted, or disable this option.

Using HostRAID Settings

After scanning the device is completed, the **Main** menu displays the following information:

- **ID**—indicates ID number of hard drive.
- **Type**—indicates available nonarray hard drive, RAID type, or global spare:
 - Striped (R0)
 - Mirrored (R1)
 - Hard Drive
 - Spare
- **Vendor**—indicates vendor of hard drive.
- **Product**—indicates model of hard drive or name of built array.
- **Size**—indicates size of hard drive.
- **Status**—indicates available RAID status:
 - **Free**—available drive
 - **Optimal**—no defect
 - **Degraded**—one drive in a mirrored array is in failed status, and a Rebuild option is available.
 - **Dead**—One drive in a RAID 0 array is in failed state or missing.
 - **Building**—the drive is a target of an ongoing Rebuild operation
 - **Verifying**—checking the data integrity of redundant data stored on fault-tolerant arrays
- **Cache**—indicates write cache setting of hard drive/RAID

- **ON**—Cache is set to *Enable* state
- **OFF**—Cache is set to *Disable* state

Array Setup

With SCSISelect, you can create arrays when you select the HostRAID® option.

Creating Arrays

Before creating the array, make sure the disks for the array are connected and installed in your system, then follow these steps:

1. Start SCSISelect <Ctrl><A>.
2. Select **Configure/View HostRAID Settings**.
3. From the **Main** menu, press **C** to create a RAID array.

 **NOTE:** You must have at least two hard drives to create an array.

 **NOTE:** If the hard drive you select is already part of an array configuration, it will not be available for selection.

4. Select the RAID type you want to build. As you highlight the selections you will get an allowance message regarding minimum and maximum drives. Press <Enter>.

The allowance messages for the different RAID types are as follows:

- **RAID-0**

Min 2 drives, max 4 drives.

- **RAID-1**

Min 2 drives, max 2 drives.

5. From the **Select RAID Member** menu, press the Spacebar to select the hard drives you want to use in the array. An X will appear next to the drives you have selected.

Creating RAID 0 Arrays

To create a RAID 0 array:

1. From the **Select RAID Type** window, select **RAID-0** and press <Enter>.
2. Select the hard drives you want to use and press <Enter>.
3. Select the stripe size and press <Enter>. You can select from 16K, 32K, or 64K (default). If a partition exists on any of the selected drives, you will get a message that the partition will be deleted.
4. Assign a RAID name by entering up to 15 alphabetic or numeric characters, then press <Enter>. The following

message appears:

Do you want to make this array bootable?

5. Select **Yes** if you want to make the array bootable. The following message appears:

Create Array?

6. Select **Yes**. The following message appears:

Are you sure?

7. Select **Yes** and press <Enter> to create a RAID 0 array. After your array is created, you will automatically return to the **Main** menu.

Creating RAID 1 Arrays

There are two ways to create a RAID 1 array. You can create a new RAID 1 array or you can migrate from an existing single drive to a RAID 1 array. To create a RAID 1 array using either option:

1. From the **Select RAID Type** window, select **RAID-1**. Select the hard drives you want using the Spacebar to toggle, then press <Enter>. The **RAID-1 Build Option** window appears.
2. Select an option and press <Enter>.

The options you can choose are:

- **Create new RAID-1**—is the default option.
- **Copy from (11) to (12)**—copy from a source drive to a target drive if the source is equal to or smaller than the target.
- **Copy from (12) to (11)**—copy from a source drive to a target drive if the source is equal to or smaller than the target.

 **NOTE:** If a valid partition table or boot block is detected in the target drive, you will get a warning message that the information will be destroyed.

3. Assign a RAID name by entering up to 15 alphabetic or numeric characters, then press <Enter>. The following message appears:

Do you want to make this array bootable?

4. Select **Yes** if you want to make the array bootable. The following message appears:

Create Array?

5. Select **Yes**. The following message appears:

Are you sure?

6. Select **Yes** and press <Enter> to create a RAID 1 array. If you select **No**, the RAID creation will terminate and you will return to the **Main** menu.

After your array is created, the progress bar will appear showing the percentage completed in the create process. If for any reason you want to stop the build process and return to the **Main** menu, press <Esc>. You may continue the build process by selecting the Rebuild function later.

 **NOTE:** You might not be able to use the array if the build has not been entirely completed.

To add a spare to an existing RAID 1 array, see "[Adding a Spare Drive](#)".

Creating a Configured Single Disk

Configured single disks contain RAID information areas called metadata. A blank single drive has no such metadata. The difference between them is their behavior when performing RAID migration. You can create a configured single disk when preparing the drives for future RAID creations.

To create configured single:

1. From the **Select RAID Type** window, select **Configured Single** and press <Enter>.
2. Select the hard drives you want to use and press <Enter>.

 **NOTE:** If a valid partition table or boot block is detected in the target drive, you will get a warning message that the dynamic partition disk(s) will be converted to the basic partition disk(s).

Managing Arrays

With SCSISelect, you can manage RAID arrays when you select the HostRAID option..

Viewing Array

To view an array, select the array and press <Enter>. A detailed view of the hard drives will appear. From this window you can see the status of the individual hard drives. The status you might see are:

- **Optimal**—no defect
- **Building**—the drive is a target of an ongoing Rebuild operation
- **Verify**—checking the data integrity of redundant data stored on fault-tolerant arrays

Missing drive information indicates that a member is missing and the array is not optimal

Adding a Spare Drive

With RAID 1 you have the option to create a maximum of 2 spare drives. You can create a spare before you define your RAID, or you can add a spare later to an existing RAID 1 array.

To create a spare prior to defining a RAID, or add to an existing RAID 1 array:

1. From the **Main** menu, press S to add a spare. The following options appear:

Add Spare

Delete Spare (only available if a spare already exists)

2. Select a drive and press <Enter>. Select **Yes** when the following message appears:

Are you Sure?

Yes/No

After you select your spare drive, it will appear as a spare in the **Main** menu.

Rebuilding Arrays

 NOTE: Rebuilding applies to Fault Tolerant arrays (RAID 1) only.

If an array Build process (or initialization) is interrupted or critical with one member missing, you must perform a Rebuild to get the array to Optimal status. For a critical array Rebuild operation, the optimal drive is the source drive. The optimal drive is the disk that has no damaged data on it and it states the current RAID status of this disk.

 NOTE: If no spare exists and a hard disk drive fails, you need to create a spare before you can rebuild an array. See "[Adding a Spare Drive](#)" before continuing your Rebuild.

To rebuild an array for RAID 1:

1. From the **Main** menu, select array for Rebuild and press **Enter**.
2. Press **R** for Rebuild.
3. If your array rebuilds successfully, the following message appears:

Build/Rebuild Completed.

Press **any key** to return to the **Main** menu.

 NOTE: During the Rebuild process, you can stop the Rebuild by pressing Esc. You will get a pop-up window displaying Stop Build? If you select Yes, you will return to the Main menu. HostRAID will set a check point when you exit Rebuild. See "[Check Point](#)" for more information.

Verifying Data Integrity

To verify data integrity, your RAID 1 must be at Optimal status. To verify data integrity:

1. From the **Main** menu, select array, press <Enter>, then press **V**.
2. Select **Yes** and press <Enter>. If you select **No**, you will return to the **Main** menu.

 NOTE: During the Verify process, you can stop the Verify by pressing Esc. You will get a pop-up window displaying Stop Verify? If you select Yes, you will return to the Main menu. HostRAID will set a check point when you exit Verify. See "[Check Point](#)" for more information.

3. You will get a message asking if you want to automatically fix errors. Press **Yes** to AutoFix. This will execute a comparison of mirrored drives, a copy from the primary drive to secondary drive when miscompare occurs, and a report at the end of the verification process.

If you select **No**, Verify will execute a comparison of mirrored drives, a log of errors, and a report at the end of the verification process.

 NOTE: To fix errors found (if any), run Verify again with Autofix=Yes.

After you select your verification option, the following message appears:

Depending on your disk capacity, verifying may take several minutes to several hours. Are you sure?

4. When your Verify is completed, you will get a verification message and log. Press <Esc> to exit.

If your Verify is unsuccessful, you will get the following message:

WARNING: Failed !!!

The array is degraded and it is recommended you start rebuilding or reconstructing one failed drive by copying data from the source disk.

5. Press <Enter> and you will return to the **Main** menu.

Bootable Array

To create a bootable array:

1. From the **Main** menu, select array, press <Enter>, then press **B** for the Bootable function.
2. Select **Mark Bootable** and press <Enter>.

 NOTE: Mark Bootable gives boot priority to the array regardless of the SCSI ID priority.

A B will appear next to the drive ID to indicate it as bootable.

Check Point

HostRAID has a check point feature that enables you to exit the SCSISelect utility when an operation (for example, Verify, or Rebuild) is in progress. The HostRAID driver will continue the operation where SCSISelect left off, and SCSISelect will continue the operation where the HostRAID driver left off, if an operation was started from the driver.

Deleting Arrays

 NOTICE: Deleting an array will result in the loss of all data on the array.

To delete an array:

1. From the **Main** menu, select the array you need to delete by moving the cursor, then press <Enter>.
2. Press **D**. The following message appears:

Delete Array?

3. For RAID 0, go to Step 4. For RAID 1, select one of these options, then continue to Step 4:
 - **Drive ID 1**—deletes all data on the drive 1
 - **Drive ID 2**—deletes all data on the drive 2
 - **Drive ID 1 & 2**—deletes all data on both drives
 - **None**—breaks the array but keeps any existing data on both drives

 NOTE: These options after deleting data or breaking the array, will revert the drives to single disks.

4. Select **Yes** and press <Enter>. The following message appears:

Are you sure?

5. Select **Yes** and press <Enter>. If you select **No**, you will return to the **Main** menu.

Using SCSI Disk Utilities

The disk utilities provide options for:

- Listing SCSI IDs and LUNs
- Verifying or Formatting a disk

Listing SCSI IDs and LUNs

With SCSISelect, you can list the SCSI IDs of devices attached to the SCSI card. This enables you to quickly verify that no devices on the SCSI bus have duplicate IDs.

To view the SCSI IDs:

1. Start SCISISelect. See "[Starting and Exiting SCISISelect](#)".

SCISISelect detects all Dell SCSI cards and displays the model number, channel letter, slot number, and PCI address for each SCSI card and channel.

2. Select the SCSI card and channel that has the devices you want to list. The Options menu appears.
3. Select SCSI Disk Utilities.

SCISISelect scans the SCSI bus (to determine the devices installed) and displays a list of all SCSI IDs and the devices assigned to each ID.

If a device does not show up in SCISISelect, check these items first:

- Is the device attached to the SCSI cable?
- Is there power to the device?
- Does the device have a unique SCSI ID?

If two devices are assigned the same ID and on the same bus, only one device or none of the devices may show up. To correct this, make sure that each device has a unique SCSI ID.

4. Use the up-arrow and down-arrow keys to move the cursor to a specific ID and device, then press <Enter>.

Verifying or Formatting a Disk

SCISISelect includes a utility that enables you to format and verify disks:

- **Verify Disk Media**—Allows you to scan the media of a hard disk drive for defects. If the utility finds bad blocks on the media, it prompts you to reassign them so they are no longer used.
- **Format Disk**—Allows you to perform a low-level format on a hard disk drive. A disk must be low-level formatted before you can use the operating system's partitioning and high-level formatting utilities. Most SCSI disk devices are preformatted at the factory and do not need to be formatted again. If a drive is not preformatted, you can use SCISISelect to perform a low-level format on the drive. This operation is compatible with most SCSI disk drives.

- ➡ **NOTICE:** A low-level format destroys all data on the drive. Be sure to back up your data before performing this operation. You cannot abort a low-level format once it is started.
- ➡ **NOTICE:** When a low-level format command is sent to the hard disk drive, the drive will start its format. The SCSI card will wait for the format to complete and may appear to be hung. You must not interfere or try to stop the low-level format as this can destroy the hard disk drive and render it unusable. A low-level format can take from several minutes to several hours to complete, depending on the size and speed of the hard disk drive. When the drive has completed its low-level format, it will send a command to the SCSI card and allow the user to exit the utility.

To use SCISISelect to format or verify a disk:

1. Start SCISISelect. See "[Starting and Exiting SCISISelect](#)".

SCISISelect detects all Dell SCSI cards and displays the model number, channel letter, slot number, and PCI address for

each card and channel.

2. Select the SCSI card and channel that has the devices you want to format or verify.

The Options menu appears.

3. Select **SCSI Disk Utilities**.

SCSISelect scans the SCSI bus and displays a list of all the SCSI IDs and the devices assigned to each ID.

4. From the list of SCSI devices, select the device you want to format or verify.

If the device has multiple logical units, and multiple LUN support is enabled for that device, a menu of LUNs appears.

5. Select the LUN of the unit you want to format or verify.

A small menu appears.

6. Select **Verify Disk Media** or **Format Disk**.
 - If you select **Verify Disk Media**, SCSISelect notifies you of bad blocks and prompts you to reassign them. Select **Yes** to reassign the bad blocks or **No** to leave them as is. You can press <Esc> at any time to abort verification.
 - If you select **Format Disk**, a prompt appears, asking you to confirm that you want to format the disk. Select **Yes** to start formatting the disk, or **No** to cancel formatting.

[Back to Contents Page](#)

Windows Operating System Driver Installation

Adaptec™ U320 SCSI RAID 0 or 1 User's Guide

- [Creating a Windows Operating System Driver Diskette](#)
- [Driver Installation with Windows Operating System - Precision Workstation](#)
- [Confirming Driver Installation](#)
- [Update Driver](#)

 NOTE: If you wish to modify any of the default settings, please refer to RAID Configuration and Management.

Creating a Windows Operating System Driver Diskette

When you install a driver in a new system or update a driver in an existing system, you need a driver diskette.

You can use the following methods to obtain drivers:

- Visit the Dell™ Support website at support.dell.com and download the latest drivers for your controller. Follow the instructions provided with the download.
- Use the drivers from the Dell OpenManage™ Server Assistant CD or Recovery CD provided with your system. Refer to the user documentation included with the Dell OpenManage Server Assistant CD, Recovery CD or driver diskette for details.

Driver Installation with Windows Operating System - Precision Workstation

To install the device driver for the Adaptec U320 SCSI RAID 0 or 1 Controller on your Dell Precision Workstation during Windows Operating System installation:

1. Boot your system from the Dell™ Windows Operating System Recovery CD.
2. Press <F6> when a message appears requesting you to press <F6> if you need to install third party SCSI or RAID drivers.
3. When the **Windows Setup** window is displayed, Press **S** to specify additional device(s).
4. Insert the driver diskette and press <Enter>.
5. The **Windows Setup** screen displays a message indicating that Setup will load support for the requested storage devices.
6. If there are any additional devices to be installed, specify them now. When all devices are specified, continue to the next step.

7. From the **Windows Setup** screen, press <Enter>. Setup loads all device files and then continues the Windows installation.

Refer to your system manual for further instructions.

Confirming Driver Installation

To confirm the device driver installation:

1. Right-click on the My Computer icon and select Manage from the popup menu.
2. From the left panel, select Device Manager.
3. Click the + in front of SCSI and RAID controllers. Adaptec U320 SCSI RAID 0 or 1 should appear.

If the Device Driver indicates a problem, see "Update Driver".

Update Driver

To update an existing device driver installation:

1. Create a driver diskette. Download the current driver from support.dell.com, and follow the instructions included with the download file to create a driver diskette.
2. Insert the Adaptec U320 SCSI RAID 0 or 1 driver diskette that you created in Step 1 into drive A:.
3. Right-click on the My Computer icon and select Manage from the popup menu.
4. From the left panel, select Device Manager.
5. Click the + in front of SCSI and RAID controllers.
6. Right-click on the Adaptec U320 SCSI RAID 0 or 1 controller and select Properties from the popup menu.
7. In the Properties dialog box, select the **Driver** tab.
8. Click the Update Driver... button and follow the Upgrade Device Driver Wizard.
9. Select Search for a suitable drive for my device (recommended), then click **Next**.
10. Under Optional search locations, check the Floppy disk drives checkbox and click Next.
11. When driver update completes, click Finish.
12. Remove the Adaptec U320 SCSI RAID 0 or 1 driver diskette from drive A: and reboot.

[Back to Contents Page](#)

[Back to Contents Page](#)

SCSI Cables and Connectors

Adaptec™ U320 SCSI RAID 0 or 1 User's Guide

For more information about qualified interface cables and connectors, go to www.dell.com or contact your Dell™ representative.

[Back to Contents Page](#)

Adaptec U320 SCSI RAID 0 or 1 Specifications

Adaptec™ U320 SCSI RAID 0 or 1 User's Guide

- [General](#)
- [Physical](#)
- [Electrical](#)
- [Environmental](#)
- [Reliability](#)

General

Specification	Description
Manufacturer	Adaptec, Inc.
Model Number	ASC-39320
Card Size	6.421 inches x 3.6 inches
Controller Interface Logic	Adaptec AIC-7902
SCSI Controller	Two Channels
Interface Revision	Ultra320 SCSI
Interface Data Transfer Rate	320 MB/s per channel
Supported Device Types	SCSI Hard Disk Drives
Number of Devices Supported	15 devices per channel/30 total devices supported
Host Bus Interface Protocol	133 MHz PCI-X
System Bus Transfer Rate	Up to 1,066 MB/s at 64-bit/133 MHz
Basic Input/Output System (BIOS)	Yes
RAID Levels Supported	RAID 0, 1
SCSI Connectors	Two 68-pin Internal LVD/SE connectors, Two 68-pin External VHDCI connectors

Physical

Specification	Feature

Height	3.6 inches
Width	6.421 inches
Depth	62.6 mils

Electrical

Specification	Description
Power Requirements	3.3/5 volts

Environmental

Specification	Feature
Operating Temperature	0 °C to 55 °C
Relative Humidity	Nonoperating 65 °C at 90% relative humidity for 24 hr. Operating 25 °C at 35% relative humidity for 24 hr. 25 °C at 80% relative humidity for 24 hr

Reliability

Specification	Feature
MTBF	889,577 hours

[Back to Contents Page](#)

Adaptec U320 SCSI RAID 0 or 1 Troubleshooting

Adaptec™ U320 SCSI RAID 0 or 1 User's Guide

- [General Problems](#)
- [BIOS Boot Error Messages](#)
- [Operating System Problems](#)
- [SCSI Cable and Connector Problems](#)
- [System CMOS Boot Order](#)
- [SMART Check](#)
- [Getting Help](#)

General Problems

The following table describes general problems you might encounter, along with suggested solutions.

Problem	Suggested Solution
Some operating systems do not load in a system with a RAID controller.	Check the system basic input/output system (BIOS) configuration for PCI interrupt assignments. Make sure a unique interrupt is assigned for the RAID controller. Initialize the logical drive before installing the operating system.
One of the hard drives in the array fails repeatedly.	<ul style="list-style-type: none">• Check the SCSI cables.• If the SCSI Cables are OK, replace the drive.• Rebuild the array.
After pressing <Ctrl><A> during bootup and trying to make a new configuration, the system hangs.	<ul style="list-style-type: none">• Check the drives IDs on each channel to make sure each device has a different ID.• Check that the channel is properly terminated. The device at the end of the channel must be terminated or the cable must have a terminator attached.• Check to make sure that the RAID controller is seated properly in the slot.• Replace the drive cable.
Pressing <Ctrl><A> does not display a menu.	A color monitor is required to display the BIOS utility menus.
At system POST (Power On Self Test) with the	The RAID controller cache memory may be defective or missing.

RAID controller installed, the BIOS banner display is garbled or does not appear at all.	
Cannot flash or update the EEPROM.	Contact Dell™ support for assistance. CAUTION: Do not perform a firmware flash update while a check consistency or background initialization process is ongoing or failure could result.
The BIOS Configuration Utility does not detect a replaced physical drive in a RAID 1 array and offer the option to start a rebuild. After the drive is replaced, the utility shows all drives online and all logical drives reporting optimal state. It does not allow rebuild because no failed drives are found.	Perform the following steps to solve this problem: <ol style="list-style-type: none"> 1. Access the BIOS configuration Utility and select Configure/View HostRAID settings. 2. Highlight the RAID array and press <Enter> 3. Press <Ctrl><R> to rebuild. After rebuilding is complete, the problem is resolved and the operating system will boot.

BIOS Boot Error Messages

The following table describes error messages about the BIOS that can display at bootup, the problems, and suggested solutions.

Message	Problem	Suggested Solution
SCSI controller configuration error	This error has resulted from insufficient system I/O resource.	<ul style="list-style-type: none"> • Reset the system CMOS to default settings. • Remove some PCI add on card.
SCSI IDx connected but not ready	Failed to respond to SCSI Test Unit Ready command. Drive not ready for spin up.	Replace drive.
SCSI IDx – Start Unit Request failed	Drive failed to spin up.	Replace drive.
Time-out failure during SCSI Inquiry Command!	The inquiry command fails to complete in a certain time interval.	Check loose cable or lower the data transfer rate.
Rescanning for SCSI devices...	Retrying the SCSI inquiry command after it fails the first time.	Check loose cable or check duplicate SCSI target ID.
EEPROM checksum error has been corrected	EEPROM checksum	BIOS will self

	mismatches with the calculated value.	correct the problem and reboot. No action required.
SEEPROM failure, now using defaults.	SEEPROM chip hardware failed.	Replace SEEPROM chip.
WARNING: The Disk Monitoring System has detected that the drive on SCSI ID: x is operating outside of normal specifications. It is advisable to immediately backup your data and replace your hard-disk drive by calling your support desk or Dell Inc.	SMART drive failure; errors exceed Failure Prediction Threshold	Backup data and replace drive.
The array configuration has changed. Press <Ctrl><A> for RAID configuration utility or press any key to continue.	The array is degraded.	Rebuild the array.
Warning: A failed drive has been forced online. This could lead to data corruption.	One member of Raid-0 has been put back online.	FYI information; no action needed.

Operating System Problems

The following table describes operating system problems you might encounter, along with suggested solutions.

Problem	Suggested Solution
SCSI controller does not appear in Device Manager	<p>The Windows® operating system may already be listing the controller under Other Devices instead of the SCSI and RAID controllers section.</p> <ol style="list-style-type: none"> 1. In Device Manager, look under Other Devices to see if it lists a PCI card or RAID controller. 2. If so, highlight this listing and click on the Properties button then click on the Driver tab. 3. Depending on your version of Windows, choose either Change Driver or Update Driver. 4. Follow the on-screen prompts to complete installation of the driver. If Windows asks if you want to test if the device can be removed safely, click on Cancel. 5. Reboot the system to complete installation of the driver.
"No Hard Drives Found" Message Appears During a CD Installation of the Windows operating system.	<p>The <F6> key was not pressed at the appropriate time during installation.</p> <ol style="list-style-type: none"> 1. Reboot the computer from the Windows Operating System CD. 2. When the message Press F6 if you need to install third party SCSI or RAID driver appears, press <F6>. 3. See the "Windows Operating System Driver Installation" section for instructions to continue with the installation. <p>If this does not correct the problem, verify device connectivity and logical device configuration.</p>

SCSI Cable and Connector Problems

If you are having problems with your SCSI cables or connectors, first check the cable connections. If still having a problem, visit the Dell's web site at www.dell.com for information about qualified small computer system interface (SCSI) cables and connectors or contact your Dell representative for information.

System CMOS Boot Order

The system boot order is determined in the system CMOS utility. Follow the instructions below to alter the boot order:

1. When your system is booting up, press <F2>.
2. From the left side the **System** menu, select **Boot Sequence** .
3. Highlight the device you want to change and use the Shift-Up/Down arrows to change the order of the devices.
4. Press <Enter> to return to the left side of the window.

 **NOTE:** Be sure to press <Enter> to validate the boot sequence. If you press <Esc> instead of <Enter>, your changes will not be saved.

5. Press **Save/Exit**

The system will reboot.

SMART Check

Predictive Failure Reporting

Self-Monitoring, Analysis and Reporting Technology (SMART) was developed to examine hard drives looking for early indications of pending drive failure. SMART is a feature that exists on the hard drive itself and not controlled by the RAID controller. All SMART messages that are passed to the driver are passed to the operating system. See your hard drive documentation to determine if your hard drive is SMART capable.

Getting Help

If the troubleshooting procedures in this document do not resolve the problem, please contact Dell™ Inc. for technical assistance (refer to the "Getting Help" section in your Dell™ system documentation). For information about your Dell™ warranty, see your system documentation.

[Back to Contents Page](#)

Adaptec U320 SCSI RAID Regulatory Information

Adaptec™ U320 SCSI RAID 0 or 1 User's Guide

- [FCC Compliance Statement](#)
- [FCC Notices \(U.S. Only\)](#)
- [CE Notice](#)
- [BSMI \(Taiwan\) Compliance Statement](#)
- [MIC Notice \(Republic of Korea Only\)](#)

Electromagnetic Interference (EMI) is any signal or emission, radiated in free space or conducted along power or signal leads, that endangers the functioning of a radio navigation or other safety service or seriously degrades, obstructs, or repeatedly interrupts a licensed radio communications service. Radio communications services include but are not limited to AM/FM commercial broadcast, television, cellular services, radar, air-traffic control, pager, and Personal Communication Services (PCS). These licensed services, along with unintentional radiators such as digital devices, including computer systems, contribute to the electromagnetic environment.

Electromagnetic Compatibility (EMC) is the ability of items of electronic equipment to function properly together in the electronic environment. While this computer system has been designed and determined to be compliant with regulatory agency limits for EMI, there is no guarantee that interference will not occur in a particular installation. If this equipment does cause interference with radio communications services, which can be determined by turning the equipment off and on, you are encouraged to try to correct the interference by one or more of the following measures:

- Reorient the receiving antenna.
- Relocate the computer with respect to the receiver.
- Move the computer away from the receiver.
- Plug the computer into a different outlet so that the computer and the receiver are on different branch circuits.

If necessary, consult a Dell Technical Support representative or an experienced radio/television technician for additional suggestions.

For additional regulatory information, refer to your system documentation.

FCC Compliance Statement

- **NOTE:** This device complies with Part 15 of the FCC Rules. Operation is subject to the following two conditions: (1) This device may not cause harmful interference, and (2) this device must accept any interference received, including interference that may cause undesired operation.

FCC Notices (U.S. Only)

Most Dell™ computer systems are classified by the Federal Communications Commission (FCC) as Class B digital devices. However, the inclusion of certain options can change the rating of some configurations to Class A. To determine which classification applies to your computer system, examine all FCC registration labels located on the bottom or back panel of your computer, on card-mounting brackets, and on the cards themselves. If any one of the labels carries a Class A rating, your entire system is considered to be a Class A digital device. If all labels carry either the Class B rating distinguished by either an FCC ID number or the FCC logo, (), your system is considered to be a Class B digital device.

Once you have determined your system's FCC classification, read the appropriate FCC notice. Note that FCC regulations provide that changes or modifications not expressly approved by Dell Inc. could void your authority to operate this equipment.

A Notice About Shielded Cables

Use only shielded cables for connecting peripherals to any Dell device to reduce the possibility of interference with radio communications services. Using shielded cables ensures that you maintain the appropriate EMC classification for the intended environment. For parallel printers, a cable is available from Dell. If you prefer, you can order a cable from Dell on the World Wide Web at: accessories.us.dell.com.

Class B

This equipment has been tested and found to comply with the limits for a Class B digital device pursuant to Part 15 of the FCC Rules. These limits are designed to provide reasonable protection against harmful interference in a residential installation. This equipment generates, uses, and can radiate radio frequency energy and, if not installed and used in accordance with the manufacturer's instruction manual, may cause interference with radio communications.

However, there is no guarantee that interference will not occur in a particular installation. If this equipment does cause harmful interference to radio or television reception, which can be determined by turning the equipment off and on, you are encouraged to try to correct the interference by one or more of the following measures:

- Reorient the receiving antenna.
- Increase the separation between the equipment and the receiver.
- Connect the equipment into an outlet on a circuit different from that to which the receiver is connected.
- Consult the dealer or an experienced radio/television technician for help.

FCC Identification Information

The following information is provided on the device or devices covered in this document in compliance with FCC regulations:

- Model number: ASC-39320
- Company name: Adaptec, inc.

Dell Inc.
One Dell Way
Round Rock, Texas 78682 USA
512-338-4400

CE Notice

Marking by the symbol  indicates compliance of this Dell computer to the EMC (Electromagnetic Compatibility) directive and the Low Voltage directive of the European Union. Such marking is indicative that this Dell system meets the following technical standards:

- EN 55022 — "Information Technology Equipment — Radio Disturbance Characteristics — Limits and Methods of Measurement."
- EN 55024 — "Information Technology Equipment - Immunity Characteristics - Limits and Methods of Measurement."
- EN 61000-3-2 — "Electromagnetic Compatibility (EMC) - Part 3: Limits - Section 2: Limits for Harmonic Current Emissions (Equipment Input Current Up to and Including 16 A Per Phase)."
- EN 61000-3-3 — "Electromagnetic Compatibility (EMC) - Part 3: Limits - Section 3: Limitation of Voltage Fluctuations and Flicker in Low-Voltage Supply Systems for Equipment With Rated Current Up to and Including 16 A."
- EN 60950 — "Safety of Information Technology Equipment."



 NOTE: EN 55022 emissions requirements provide for two classifications:

- Class A is for typical commercial areas.
- Class B is for typical domestic areas.

This Dell device is classified for use in a typical Class B domestic environment.

A "Declaration of Conformity" in accordance with the preceding directives and standards has been made and is on file at Dell Inc. Products Europe BV, Limerick, Ireland.

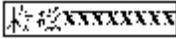
BSMI (Taiwan) Compliance Statement

If you find a  or  mark on the regulatory label on the bottom, side, or back panel of your computer, the following section is applicable:

BSMI通告 (僅限於台灣)

大多數的 Dell 電腦系統被 BSMI (經濟部標準檢驗局) 劃分為乙類數位裝置。但是, 使用某些選件會使有些組態的等級變成甲類。若要確定您的電腦系統適用等級, 請檢查所有位於電腦底部或背面板、擴充卡安裝托架, 以及擴充卡上的 BSMI 註冊標籤。如果其中有一甲類標籤, 即表示您的系統為甲類數位裝置。如果只有 BSMI 的檢磁號碼標籤, 則表示您的系統為乙類數位裝置。

一旦確定了系統的 BSMI 等級, 請閱讀相關的 BSMI 通告。請注意, BSMI 通告規定凡是未經 Dell Inc. 明確批准的擅自變更或修改, 將導致您失去此設備的使用權。

此裝置符合 BSMI (經濟部標準檢驗局) 的規定, 使用時須符合以下兩項條件:

- 此裝置不會產生有害干擾。
- 此裝置必須能接受所接收到的干擾, 包括可能導致無法正常作業的干擾。

甲類

此設備經測試證明符合 BSMI (經濟部標準檢驗局) 之甲類數位裝置的限制規定。這些限制的目的是為了在商業環境中使用此設備時, 能提供合理的保護以防止有害的干擾。此設備會產生、使用並散發射頻能量; 如果未遵照製造廠商的指導手冊來安裝和使用, 可能會干擾無線電通訊。請勿在住宅區使用此設備。

警告使用者:
這是甲類的資訊產品, 在居住的環境中使用時, 可能會造成射頻干擾,
在這種情況下, 使用者會被要求採取某些適當的對策。

乙類 乙類

此設備經測試證明符合 BSMI (經濟部標準檢驗局) 之乙類數位裝置的限制規定。這些限制的目的是為了在住宅區安裝時, 能防止有害的干擾, 提供合理的保護。此設備會產生、使用並散發射頻能量; 如果未遵照製造廠商的指導手冊來安裝和使用, 可能會干擾無線電通訊。但是, 這並不保證在個別的安装中不會產生干擾。您可以透過關閉和開啓此設備來判斷它是否會對廣播和電視收訊造成干擾; 如果確實如此, 我們建議您嘗試以下列一種或多種方法來排除干擾:

- 重新調整天線的接收方向或重新放置接收天線。
- 增加設備與接收器的距離。
- 將設備連接至不同的插座, 使設備與接收器連接在不同的電路上。
- 請向經銷商或有經驗的無線電 / 電視技術人員查詢, 以獲得幫助。

MIC Notice (Republic of Korea Only)

To determine which classification (Class A or B) applies to your computer (or other Dell digital device), examine the Republic of Korean Ministry of Information and Communications (MIC) registration labels located on your computer (or other Dell digital device). The MIC label may be located separately from the other regulatory marking applied to your product. Line two of the label identifies the emissions class for the product—"(A)" for Class A products or "(B)" for Class B products.

 NOTE: MIC emissions requirements provide for two classifications:

- Class A devices are for business purposes.
- Class B devices are for nonbusiness purposes.

기종별	사용자안내문
B급 기기 (가정용 정보통신기기)	이 기기는 가정용으로 전자파적합등록을 한 기기로서 주거지역에서는 물론 모든 지역에서 사용할 수 있습니다.

Please note that this device has been approved for nonbusiness purposes and may be used in any environment, including residential areas.

[Back to Contents Page](#)

Adaptec U320 SCSI RAID Glossary

Adaptec™ U320 SCSI RAID 0 or 1 User's Guide

[A](#) [B](#) [C](#) [D](#) [E](#) [F](#) [G](#) [H](#) [I](#) [L](#) [M](#) [O](#) [P](#) [R](#) [S](#) [T](#) [V](#)

To locate a information regarding a specific topic, scroll through the list of topics listed below or click a letter above.

A

activity

See [task](#).

array

A logical disk created from available space and made up of one or more segments on one or more physical disks. Arrays are typically used to provide data redundancy or enhanced I/O performance.

array initialization

See [initialize](#).

B

bootable array

Array configured as the boot device.

build

Background initialization of a redundant array. The array is accessible throughout. RAID 1 copies the contents of the primary drive to a secondary drive.

bus

See [channel](#).

C

cache

Fast-access memory on the controller that serves as intermediate storage for data that is read from, or written to, drives.

capacity

Total usable space available in megabytes or gigabytes.

channel

Any path, or *bus*, used for the transfer of data and the control of information between storage devices and a RAID controller.

D

degraded

A redundant (for example, a RAID 1) array in which one or more members have failed. The data is intact but redundancy has been compromised. Any further failure would cause the array to fail and result in data loss.

discovery

The process by which information about a system or subsystem is obtained.

disk

See [hard disk](#).

disk ID

Consists of the bus number, SCSI ID, and LUN, for example, 1:04:0. See also [bus](#); [LUN](#); [SCSI ID](#).

drive light

An indicator light on a disk that illuminates during read or write operations.

E

enclosure

A physical housing for hard disks, which can be connected internally or externally to a computer. An enclosure usually contains one or more power supplies, fans, and temperature sensors.

enclosure ID

Consists of the bus number, SCSI ID, and LUN, for example, 1:04:0. See also bus; LUN; SCSI ID.

enclosure management device

See [enclosure](#).

event

A notification or alert from the system indicating that a change has occurred.

event log

A file used to maintain information about prior controller activities or errors.

event notification

The means used by the system to communicate information about event occurrence.

F

failed

State of a nonredundant array that has suffered a single drive failure, or a redundant array that has suffered multiple drive failures. A failed array is inaccessible and data is lost.

failover drive

See [hot spare](#).

fault tolerance

The ability of a system to keep working in the event of hardware or software faults. Fault tolerance is usually achieved by duplicating key components of the system.

fault-tolerant arrays

Arrays that have duplicate components (RAID 1 and RAID 10).

G

Global Spare

A spare hard disk that automatically replaces a failed hard disk on any array associated with any HBA.

H

hard disk

A physical hard disk on a SCSI bus.

host adapter

Electronic circuitry that supports I/O to storage devices, but which does not support RAID.

HostRAID

Intelligent RAID on chip. Adaptec product that adds entry-level RAID functionality to SCSI ASICs and host bus adapters.

hot spare

A hard drive, an array member, that is not used in day-to-day data storage but, instead, is reserved for use as a replacement for one of the other drives in the array in the event of a failure.

I

initialize

Process of preparing a disk for use by the controller. When a disk is initialized, the controller records the RAID

signature on the disk.

initialized array

An array that is ready for data reads and writes.

L

logical device

A read/write resource, such as an array or spare, that does not exist until configured by the Software Management tool.

Logical Unit Number

See [LUN](#).

low-level format

Process performed by the drive firmware that completely removes the file system from the disk.

LUN

Stands for Logical Unit Number. The number assigned to a subdevice (logical unit) of a SCSI target. Each SCSI target can contain up to eight subdevices numbered 0 through 7; however, most SCSI devices contain only one subdevice (LUN 0).

M

mirroring; mirrored array

Synonym for RAID 1. Full redundancy is obtained by maintaining identical copies of data on two or more hard disks. Mirroring provides fault tolerance with a minor performance penalty.

monitoring

The process of receiving, displaying, and logging system events.

O

off-line array

An array that is not responding.

optimal

The state of an array when it is fully operational. For redundant arrays, the entire array is protected.

P**parity**

In RAID, a form of redundancy used to recreate the data of a failed hard disk in a disk array. Used in RAID levels 2, 3, 4, and 5.

physical resources

The Adaptec Family Adapter products, channels, and SCSI devices installed in the server.

poll

A validation of discovery information.

R**RAID**

Acronym for Redundant Array of Independent (Inexpensive) Disks. Coined in 1987 by researchers at the University of California at Berkeley to describe a set of disk array architectures that provide fault tolerance and improved performance.

RAID 0 (striping)

A single-level array consisting of two or more equal-sized segments residing on different disks. RAID 0 distributes data evenly across its respective drives in equal-sized sections called stripes. RAID 0 arrays are not redundant.

RAID 1 (mirrored)

Single-level array consisting of two equal segments residing on two different drives. Provides redundancy by storing identical copies on two drives.

rebuild

The regeneration and writing onto one or more replacement hard disks of all the data from a failed hard disk in a redundant RAID array. Rebuild is usually performed in the background while applications are accessing data in the array.

reconstruction

See [rebuild](#).

redundancy

Maintaining duplicates for any given component in a system so the system can automatically replace a failed component with a working substitute. A parity RAID array's members are redundant since surviving members may collectively replace the data from a failed hard disk.

S

SCSI

Stands for Small Computer System Interface. A parallel interface standard used to connect various types of peripheral device, (such as disk drives) to computers. Although SCSI is an ANSI standard, it exists in several variations.

SCSI array

A group of hard disks connected to the same SCSI array controller and accessed as a single storage unit. It is not apparent to users that an array is actually more than one disk drive.

SCSI array controller

The electronic circuitry used to control a SCSI array.

SCSI Device ID

See [SCSI ID](#).

SCSI ID

The number assigned to each SCSI device attached to a SCSI bus. See also [bus](#); [disk ID](#).

server

A computer set up to provide services used by other computers in a network environment. Typical servers handle disk storage, e-mail, or database functions.

SMART

Stands for Self-Monitoring Analysis and Reporting Technology. Hard disks that support this technology continually analyze their performance and generate an alert if they determine that the hard disk is likely to fail in the next few hours.

spare

A disk drive that is assigned to one or more arrays and kept in reserve in case of drive failure. A spare automatically replaces a failed drive in an array.

stand-alone hard disk

A hard disk that is not part of an array.

stripe size

The size that is used to stripe data or parity information across the disks in the array.

striping, disk; striped array

Spreading data over multiple disks to enhance performance. Often referred to as RAID 0, simple data striping provides no redundancy scheme and is not technically a standardized RAID level.

subsystem

The collection of software and hardware that controls storage to be managed and monitored.

system

Used generically to refer to a server, a networked client, or a stand-alone workstation.

T**target ID**

See [SCSI ID](#).

task

An operation that occurs only on the RAID controller, asynchronous to all other operations; for example, initializing a disk or verifying an array. Some tasks can take an extended period of time, particularly if the RAID controller is also performing intensive data I/O while the task is running.

V**verify**

The process of checking the integrity of redundant data stored on fault-tolerant arrays.

virtual device

Arrays and spares that do not exist until they are configured on the server with HostRAID.

virtual device order

The sequence in which the server's operating system detects the arrays, single hard disks, and other devices connected to the controller when the server boots.

[Back to Contents Page](#)